

Multi-Voltage Low Power Verification Tools Suite Installation Guide

Version 2009.06, June 2009

Comments?

E-mail your comments about this manual to:
mvsupport@synopsys.com.

SYNOPTSYS[®]

Copyright Notice and Proprietary Information

Copyright © 2009 Synopsys, Inc. All rights reserved. This software and documentation contain confidential and proprietary information that is the property of Synopsys, Inc. The software and documentation are furnished under a license agreement and may be used or copied only in accordance with the terms of the license agreement. No part of the software and documentation may be reproduced, transmitted, or translated, in any form or by any means, electronic, mechanical, manual, optical, or otherwise, without prior written permission of Synopsys, Inc., or as expressly provided by the license agreement.

Right to Copy Documentation

The license agreement with Synopsys permits licensee to make copies of the documentation for its internal use only. Each copy shall include all copyrights, trademarks, service marks, and proprietary rights notices, if any. Licensee must assign sequential numbers to all copies. These copies shall contain the following legend on the cover page:

This document is duplicated with the permission of Synopsys, Inc., for the exclusive use of _____ and its employees. This is copy number _____.”

Destination Control Statement

All technical data contained in this publication is subject to the export control laws of the United States of America. Disclosure to nationals of other countries contrary to United States law is prohibited. It is the reader's responsibility to determine the applicable regulations and to comply with them.

Disclaimer

SYNOPSYS, INC., AND ITS LICENSORS MAKE NO WARRANTY OF ANY KIND, EXPRESS OR IMPLIED, WITH REGARD TO THIS MATERIAL, INCLUDING, BUT NOT LIMITED TO, THE IMPLIED WARRANTIES OF MERCHANTABILITY AND FITNESS FOR A PARTICULAR PURPOSE.

Registered Trademarks (®)

Synopsys, AMPS, Cadabra, CATS, CRITIC, CSim, Design Compiler, DesignPower, DesignWare, EPIC, Formality, HSIM, HSPICE, iN-Phase, in-Sync, Leda, MAST, ModelTools, NanoSim, OpenVera, PathMill, Photolynx, Physical Compiler, PrimeTime, SiVL, SNUG, SolvNet, System Compiler, TetraMAX, VCS, Vera, and YIELDirector are registered trademarks of Synopsys, Inc.

Trademarks (™)

AFGen, Apollo, Astro, Astro-Rail, Astro-Xtalk, Aurora, AvanWaves, Columbia, Columbia-CE, Cosmos, CosmosEnterprise, CosmosLE, CosmosScope, CosmosSE, DC Expert, DC Professional, DC Ultra, Design Analyzer, Design Vision, DesignerHDL, Direct Silicon Access, Discovery, Encore, Galaxy, HANEX, HDL Compiler, Hercules, Hierarchical Optimization Technology, HSIMplus, HSPICE-Link, iN-Tandem, i-Virtual Stepper, Jupiter, Jupiter-DP, JupiterXT, JupiterXT-ASIC, Liberty, Libra-Passport, Library Compiler, Magellan, Mars, Mars-Xtalk, Milkyway, ModelSource, Module Compiler, Planet, Planet-PL, Polaris, Power Compiler, Raphael, Raphael-NES, Saturn, Scirocco, Scirocco-i, Star-RCXT, Star-SimXT, Taurus, TSUPREM-4, VCS Express, VCSi, VHDL Compiler, VirSim, and VMC are trademarks of Synopsys, Inc.

Service Marks (SM)

MAP-in, SVP Café, and TAP-in are service marks of Synopsys, Inc.

SystemC is a trademark of the Open SystemC Initiative and is used under license.

ARM and AMBA are registered trademarks of ARM Limited.

Saber is a registered trademark of SabreMark Limited Partnership and is used under license.

All other product or company names may be trademarks of their respective owners.

Contents

Chapter 1, Installing Multi-Voltage Low Power Verification Tools

Software and Hardware Requirements	2
Downloading the Low Power Verification Tools	2
Installing the Low Power Verification Tools	3
Installing Through the CLI	4
Installing Through the GUI	11
Setting up the Tool Environment	20
Setting up the License	21
Verifying the Installation	22
Understanding the Installation Directory Structure	23

1

Installing Multi-Voltage Low Power Verification Tools

The multi-voltage low power verification tools suite installation guide provides instructions to download, install, set up, and verify the low power verification tools. This guide contains the following sections:

- [“Software and Hardware Requirements” on page 2](#)
- [“Downloading the Low Power Verification Tools” on page 2](#)
- [“Installing the Low Power Verification Tools” on page 3](#)
- [“Setting up the Tool Environment” on page 20](#)
- [“Setting up the License” on page 21](#)
- [“Verifying the Installation” on page 22](#)
- [“Understanding the Installation Directory Structure” on page 23](#)

Software and Hardware Requirements

The following table lists the supported operating systems and system memory requirements to install the low power verification tools, as specified in the Synopsys® Qualified System Configuration C (QSC-C) for low power verification tools.

Operating Systems	AMD or Intel 32-bit systems or 64-bit systems: <ul style="list-style-type: none">•Red Hat Enterprise Linux v4•Red Hat Enterprise Linux v5
Memory Requirements	Minimum 500 MB in 32-bit and 64-bit systems Note:The physical memory, swap space (virtual memory), cache, and processor speed requirements are dependent on your design size, number of islands, and crossovers. Large designs require more memory and faster processors.

Downloading the Low Power Verification Tools

Ensure that you have obtained the license for low power verification tools from Synopsys, Inc. To obtain a license, contact your local technical or sales representative from Synopsys.

Download the appropriate installation file from the [Synopsys FTP Web site](#) to a temporary directory. The installation file contains:

- A platform-independent or common file — Independent of any operating system
- A platform-specific file — Specific to your operating system and hardware platform

Note: You can also download the installation file from the Synopsys Electronic Software Transfer (EST) system. To download from Synopsys EST, go to [Synopsys download page](#) and click **HTTPS Authenticated Access** or **FTP Authenticated Access**.

Installing the Low Power Verification Tools

You can use the Synopsys Installer, which includes the installation scripts to install the low power verification tools using the [Command-Line Interface \(CLI\)](#) or [Graphical User Interface \(GUI\)](#).

If you do not have the Synopsys Installer, download it from the [Synopsys installation page](#). You can also determine the most recent version of Synopsys Installer in this page.

For more information on downloading and configuring the installer, see the `installer_INSTALL_README.txt` file in the `rev/installer_<x.y>` directory, where `<x.y>` is the latest version of the Synopsys Installer.

Note: The Synopsys Installer is required only to install products that have a common file. You need to download the installer only once per release.

Installing Through the CLI

To install through the CLI:

1. At the CLI, type `installer` and press ENTER.

```
% installer
```

The text installer invokes.

If you invoke the text installer from a directory that does not contain the installation file (such as `$HOME`), the prompt to specify the path to the temporary directory where you have downloaded the installation file appears.

```
Enter the path to the top-level directory
containing the EST (ftp) or CD/DVD-ROM product
files for this release
[<default_directory_path_displayed_by_the_insta
ller>]:
```

Note: If you invoke the installer from the temporary directory, you will not be prompted to type the directory path.

2. Check if the path to the temporary directory is same as the default directory path that appears in the prompt. If same, press ENTER. If different, type the path to the temporary directory and press ENTER.

The prompt to select a product release appears.

The following releases are available under
/<installation_directory_path>/InstallerImage:

```
[ 1] C-2009.06    - (VCS)
```

```
[ 2] C-2009.06    - (mvtools)
```

Select a release to install [1]:

3. Type the number associated with the release and press ENTER.

For example, if you want to select the
C-2009.06 - (mvtools) release, type 2 and press ENTER.

The prompt to specify your site ID number appears.

Your site ID number is in the upper-right corner
of your Synopsys license key certificate. If you
have trouble locating it, contact your Synopsys
representative.

```
Site ID number [000]:
```

4. Type the Site ID number and press ENTER.

The prompt to specify the name of your site administrator appears.

The site administrator is your site's main contact
for Synopsys licensing and other tool issues. You
can leave your own name or type a different name.

```
Site administrator [<Your_Name>]:
```

By default, the installer displays the user name of the computer
where you are about to install the product.

5. Type the name of your site administrator and press ENTER.

The prompt to enter the contact information of your site administrator appears.

The contact information is the phone number and/or e-mail address of the site administrator.

```
Site contact information  
[<user_name>@company.com]:
```

By default, the installer displays the e-mail address of the user on whose computer the product is installed.

6. Type the contact information of your site administrator and press ENTER.

The prompt to select the products to install appears.

```
Select Synopsys product(s) to install:
```

```
[1] VCS
```

```
[2] mvtools - Low Power Verification Tools
```

```
Enter the list of product(s) to install [1]:
```

7. Type the number associated with the product and press ENTER.

The prompt to install common files for the selected product appears.

```
The platform-independent package for a particular
product contains support files that are common
to all the platforms.
```

```
The first time you install a product to a
directory, you must install the platform-
independent package (common file).
```

```
Install common file for product mvtools [yes]:
```

8. Press ENTER to install common files. Otherwise, type no.

The prompt to select one or multiple platforms to install the selected product appears.

```
The common package will be installed for mvtools
```

```
Select platform(s) to install:
```

```
[ 1] amd64 - Linux AMD Opteron; 64-bit
```

```
[ 2] linux - Red Hat Linux 7.2
```

```
Enter the list of platform(s) to install [1]:
```

9. Type the number associated with the platform and press ENTER.

If you want to install the selected product on all the listed platforms, type the numbers associated with each platform separated by a space. For example, 1 2.

Note:If you want to install the product on multiple operating systems, you need to install the platform-independent package only once for each product. The platform-independent package contains files that are common to all the supported platforms.

The prompt to enter the complete path to a new directory for installing the selected product appears.

```
Platform(s) selected: amd64
```

```
Enter the full path to the directory where you
want to install Synopsys C-2009.06 products. If
the directory does not exist, it will be created.
[/<installation_directory_path>/
<selected_product_to_install>]:
```

10. Type the complete path to a new directory and press ENTER.

Note:Do not type the path to the temporary directory where you downloaded the Synopsys installation file.

If the name of a new directory does not exist, the prompt to create a new directory appears.

```
Create destination directory
/<installtion_directory_path>? Answer Yes to
create the directory or No to select another
directory. [yes]:
```

11. Press ENTER, if you want to create a new directory.

The prompt to verify the information that you entered in the text installer appears.

Here is your final selection for installing Synopsys Tools:

VERSION: C-2009.06

PRODUCTS: mvtools

PLATFORMS: amd64

Synopsys Media Directory (from):
/<temporary_directory_path>

Synopsys Install Directory (to):
/<installtion_directory_path>

Platform-Independent Package(s) for : mvtools

Disk space required: 378 MB

Disk space available: 171801 MB

If all the information is correct, continue with the installation.

Install? [yes]:

12. Press ENTER, if all the information you entered is correct.

The CLI installer displays the following text messages after the successful installation of low power verification tools.

```
Installer: Extracting mvtools_v  
C-2009.06_amd64.tar ...
```

```
Installer: Extracting mvtools_v  
C-2009.06_common.tar ...
```

```
Installing amd64 code for product mvtools
```

```
Installing platform_independent code for product  
mvtools
```

```
Create site_info...
```

```
Installation has finished successfully.
```

Installing Through the GUI

To install through the GUI:

1. At the CLI, type `installer -gui` and press ENTER.
 `% installer -gui`

The Synopsys Installer window appears.



2. Click **Start**.

The Browse for an Installation Directory window appears.

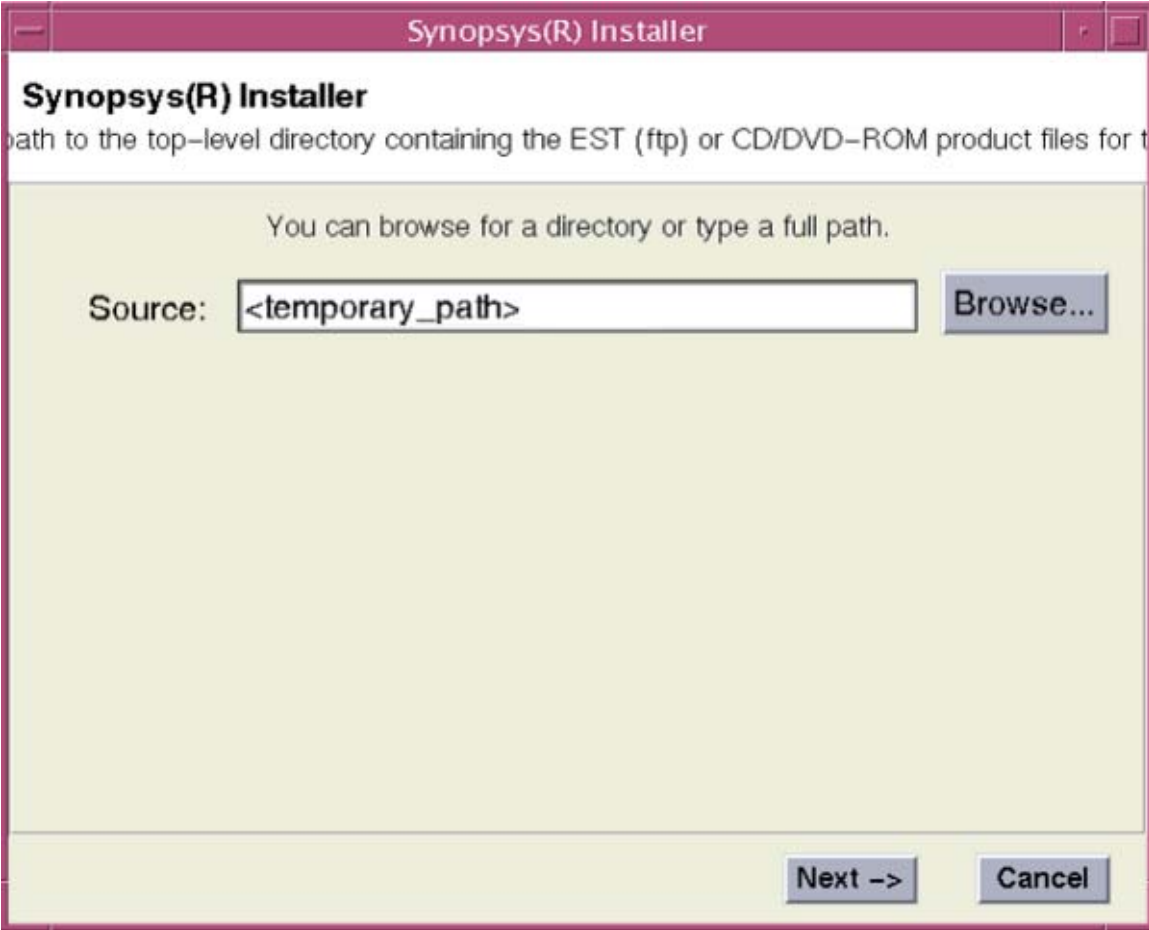

3. Click **Browse** or type the complete path to the temporary directory that contains the installation file you downloaded from the Synopsys FTP Web site.
4. Click **Next**.

The Select a Release window appears.

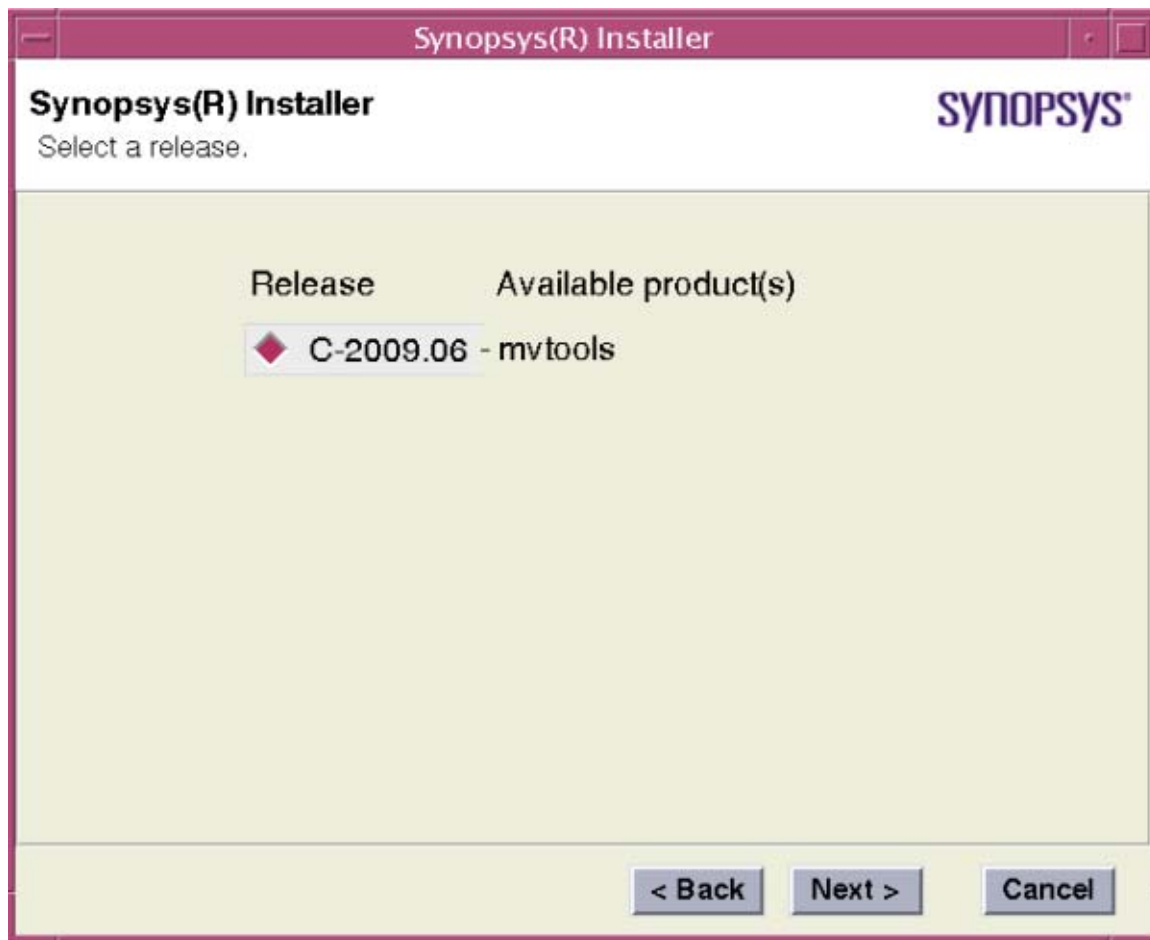

5. From the available releases, select the product release you want to install.

By default, the most recent version of the product is selected.

6. Click **Next**.

The Site Information window appears.

The screenshot shows a window titled "Synopsys(R) Installer" with the Synopsys logo in the top right. Below the title bar, the text "Synopsys(R) Installer" and "Enter information about your site." is displayed. The main area contains three input fields with placeholder text: "Site ID Number:" with "<site_ID>", "Site Administrator:" with "<Name>", and "Contact Information:" with "<email_ID>". Each field is followed by a descriptive paragraph. At the bottom, there are three buttons: "< Back", "Next >", and "Cancel".

Synopsys(R) Installer SYNOPSYS®

Enter information about your site.

Site ID Number:

Your site ID number is in the upper-right corner of your Synopsys license key certificate. If you have trouble locating it, contact your Synopsys sales representative.

Site Administrator:

The site administrator is your site's main contact for Synopsys licensing and other tool issues. You can leave your own name or type a different name.

Contact Information:

Phone number and/or e-mail address of the site administrator.

7. Enter your site ID number (available from the Synopsys license key certificate), name, and contact information (e-mail or phone number) of your site administrator.

8. Click **Next**.

The Select Products to Install window appears.

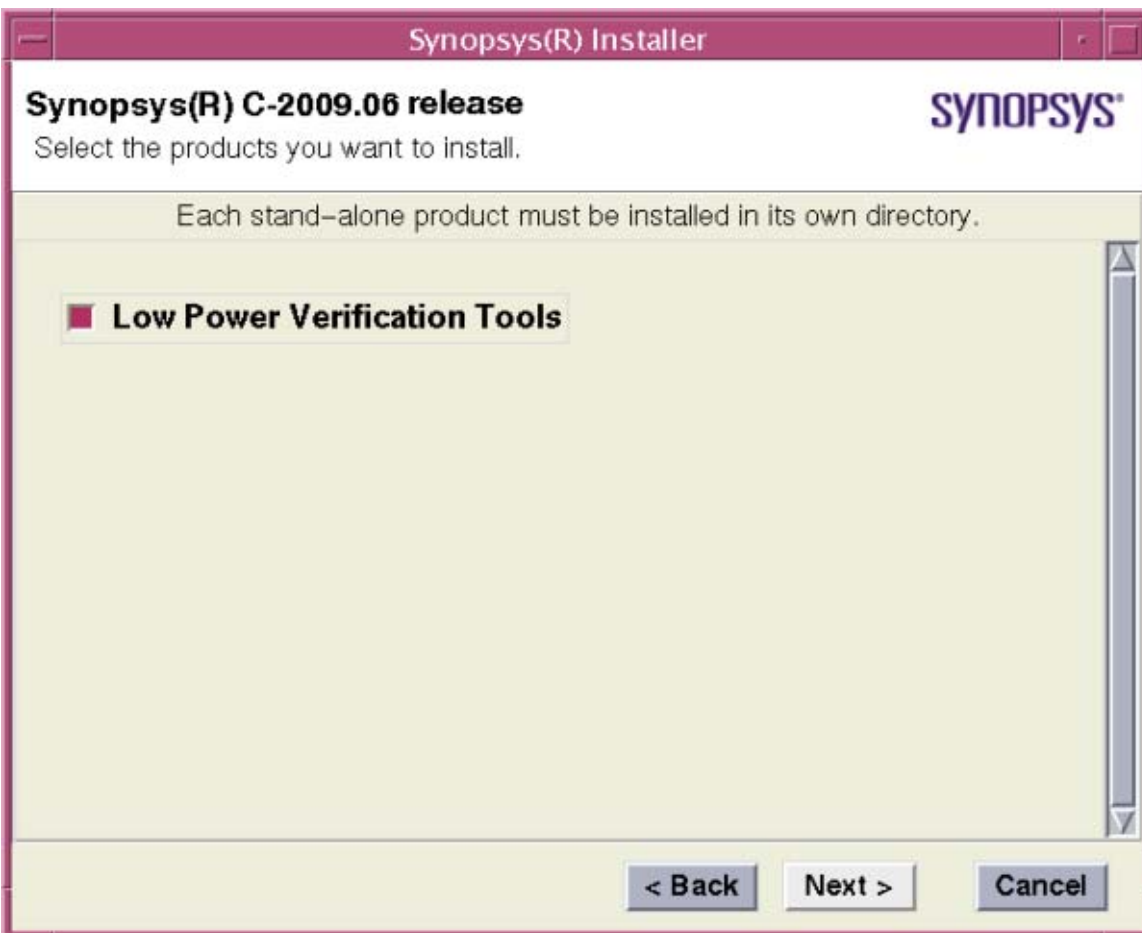

9. From the list of available products, select the relevant product to install.

Note: The products that appear in this window are a result of your release and product selection during the installation process earlier.

10. Click **Next**.

The Select Platforms window appears.

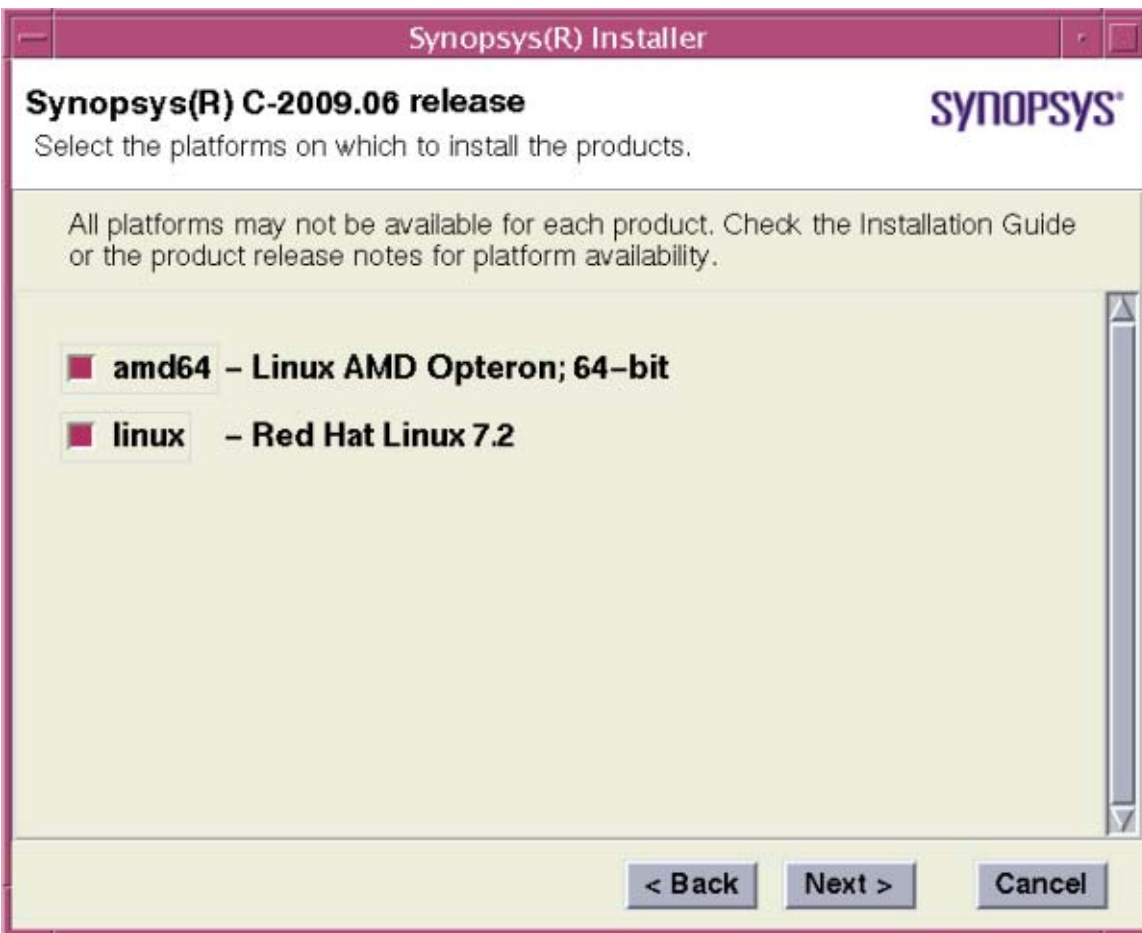

11. Select the platforms on which you want to install the product.

12. Click **Next**.

The Select the Destination Directory window appears.

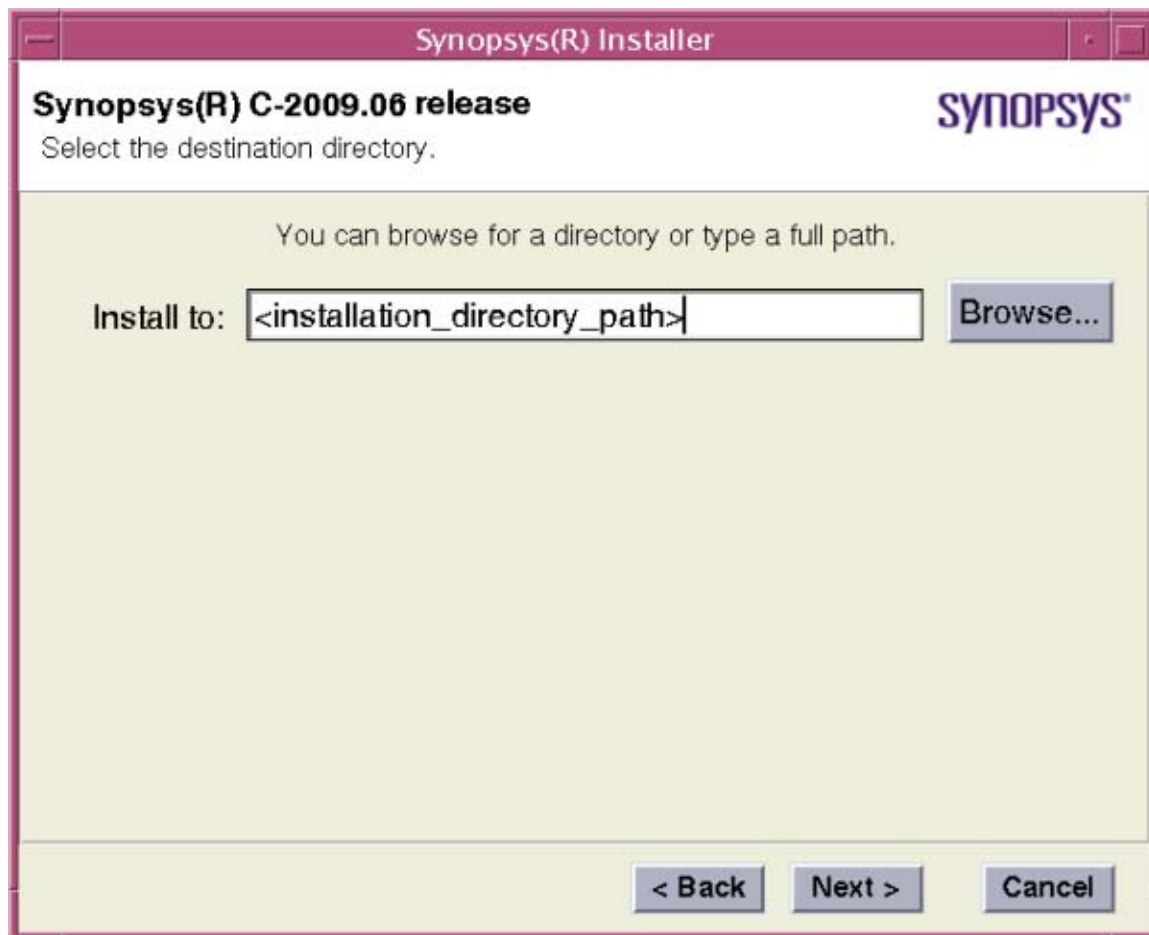

13. Click **Browse** to select a directory or type the complete path to the directory where you want to install the product.

If the directory that you are looking for does not exist, then the installer prompts to create a new directory.

14. Click **Next**.

The Verify Selected Information window appears.

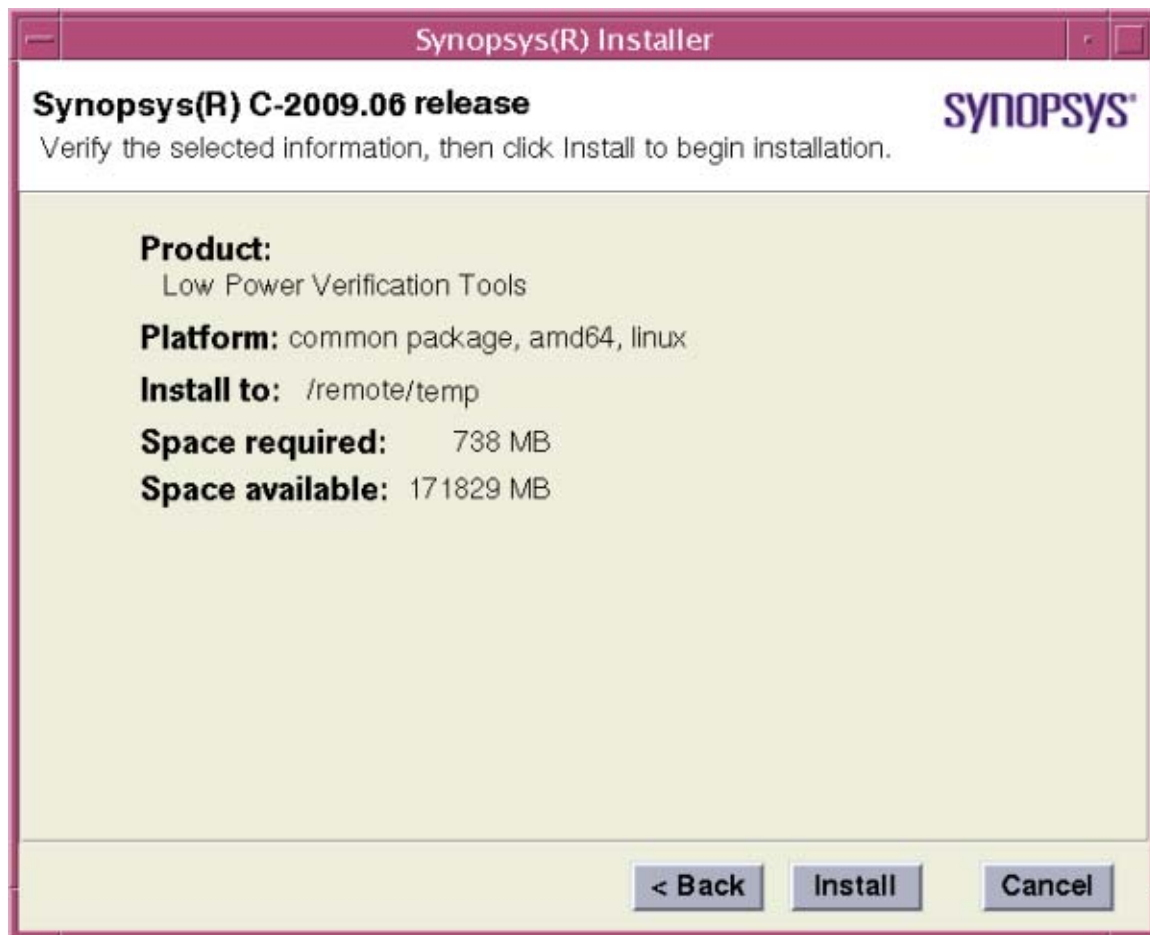

15. Verify if all the information you entered is correct.

16. Click **Install**.

After the installation is complete, the Installer Exit window appears.

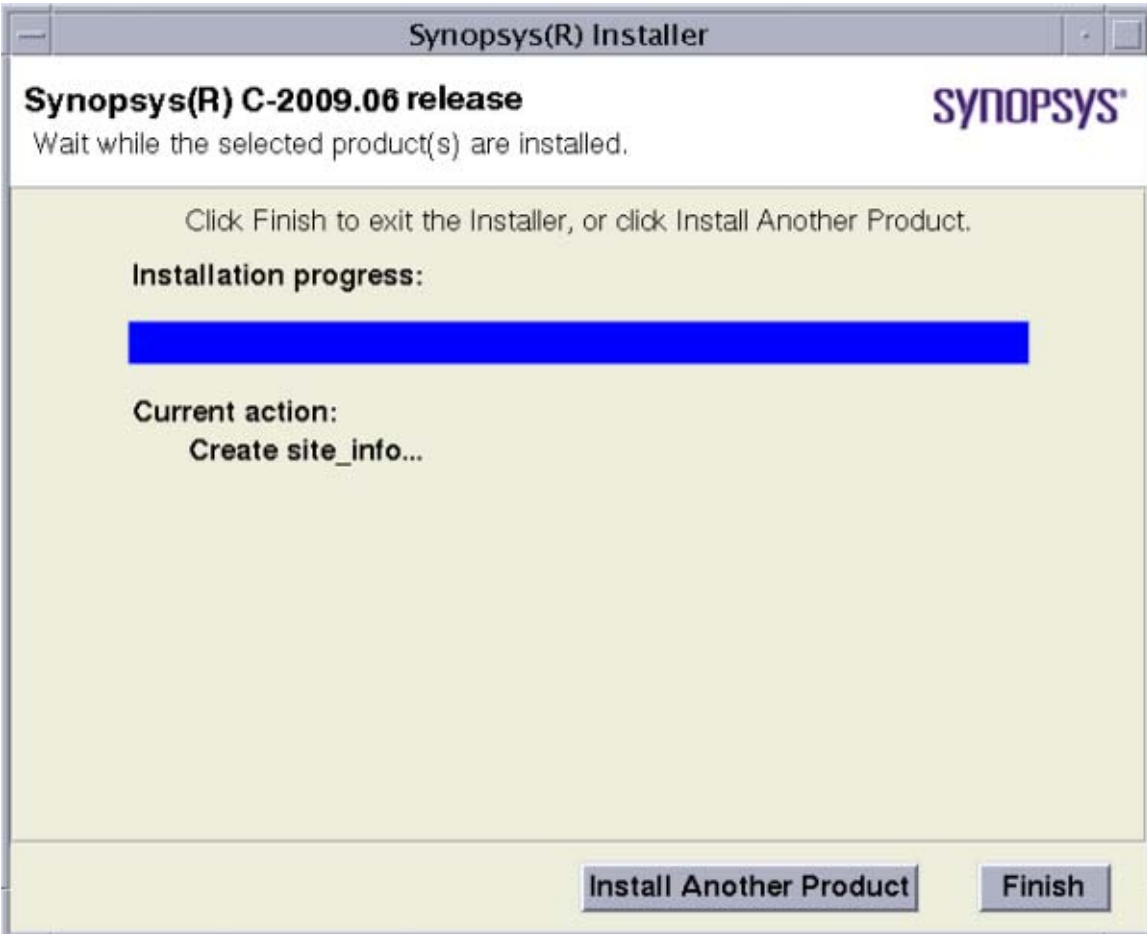

If you want to install another product, click **Install Another Product**.

17. Click **Finish** to exit the installer.

Setting up the Tool Environment

You must set the following environment variables for your setup environment to identify the location of low power verification tools on your computer and invoke them.

1. Set the `ARCHPRO_ROOT` environment variable to the installation directory.

```
setenv ARCHPRO_ROOT <installation_path>
```

2. Append `PATH` to the `bin` directory of `ARCHPRO_ROOT` to identify the binary files.

```
setenv PATH ${ARCHPRO_ROOT}/bin:$PATH
```

3. Append `LD_LIBRARY_PATH` to the `lib` directory of `ARCHPRO_ROOT` to identify the library files on your installation platform.

```
setenv LD_LIBRARY_PATH ${ARCHPRO_ROOT}/linux/  
lib:${ARCHPRO_ROOT}/amd64/lib:$LD_LIBRARY_PATH
```

Setting up the License

Before you start using the low power verification tools, you must set up the license obtained from Synopsys.

To set up the license:

1. Open the license file.
2. Use the Synopsys Common Licensing (SCL) 10.9.3 to validate your license for low power verification tools.

For more information on using SCL, see <http://www.synopsys.com/keys>.

Note: Synopsys low power verification tools support the license queuing feature. If you do not have a license for low power verification tools, the license queuing feature allows your setup environment to wait until an existing license is released by another user. To enable this feature, you need to set the `ARCHPRO_LIC_WAIT` environment variable.

```
% setenv ARCHPRO_LIC_WAIT
```

The `ARCHPRO_LIC_WAIT` environment variable is not set by default.

Verifying the Installation

To verify whether the installation of low power verification tools is successful, execute the following commands and check whether you get similar output for each command.

- `% which mvrc`

Output displays the complete path to the MVRC binary directory

- `% mvrc -version`

Output displays the MVRC banner, which includes the version of MVRC, installation date, and copyright information.

- `% mvcmp -version`

Output displays the MVCMP banner, which includes the version of MVCMP, installation date, and copyright information.

- `% mvdbgen -version`

Output displays the MVDBGEN banner, which includes the version of MVDBGEN, installation date, and copyright information.

Understanding the Installation Directory Structure

The directory where you installed the low power verification tools contains the files and directories illustrated in the following figure.

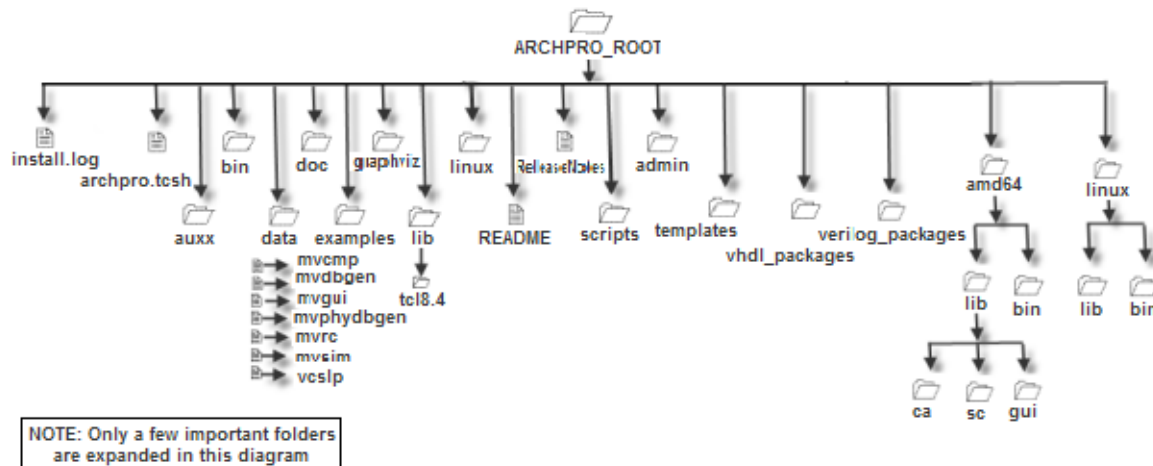

If you encounter any issues in the installation process, refer to the SolvNet article [Synopsys Installer 2.x Troubleshooting](#).

You can also send an [e-mail](#) to the Multi-voltage low power verification support team.

For the most recent updates on low power verification tools, see the [low power verification page](#) on the Synopsys Web site.

